

**ENERGIZER E95**

**D**

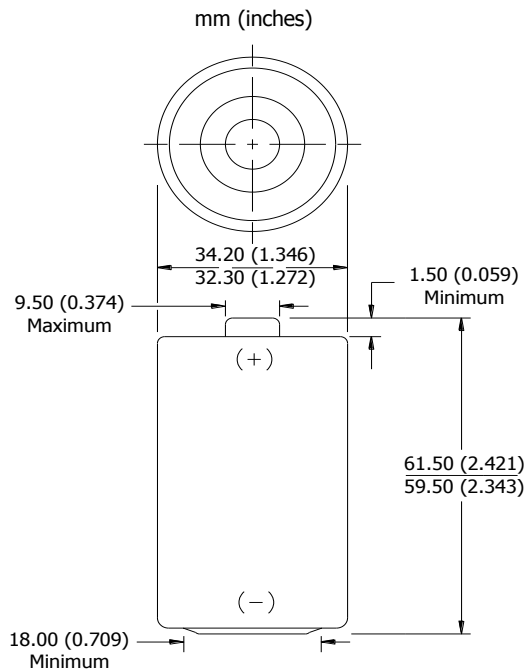

**Industry Standard Dimensions**



**Specifications**

|                         |  |
|-------------------------|--|
| <b>Classification:</b>  | Alkaline   |
| <b>Chemical System:</b> | Zinc-Manganese Dioxide (Zn/MnO <sub>2</sub> )<br>No added mercury or cadmium |
| <b>Designation:</b>     | ANSI-13A, IEC-LR20   |
| <b>Nominal Voltage:</b> | 1.5 volts  |
| <b>Nominal IR:</b>      | 150 to 300 milliohms (fresh)   |
| <b>Operating Temp:</b>  | -18°C to 55°C (0°F to 130°F)   |
| <b>Typical Weight:</b>  | 148.0 grams (5.2 oz.)  |
| <b>Typical Volume:</b>  | 56.0 cubic centimeters (3.4 cubic inch)                                      |
| <b>Jacket:</b>          | Plastic Label  |
| <b>Shelf Life:</b>      | 10 years at 21°C   |
| <b>Terminal:</b>        | Flat Contact   |

**Milliamp-Hours Capacity**

Continuous discharge to 0.8 volts at 21°C

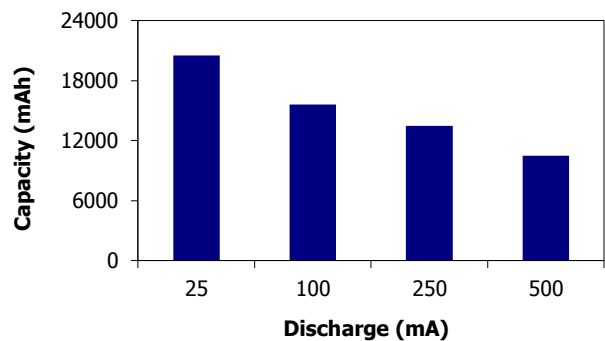

**Device Selection Guide:**

Portable Stereo



Toy



Lighting



Radio



**Battery Selection Indicator**

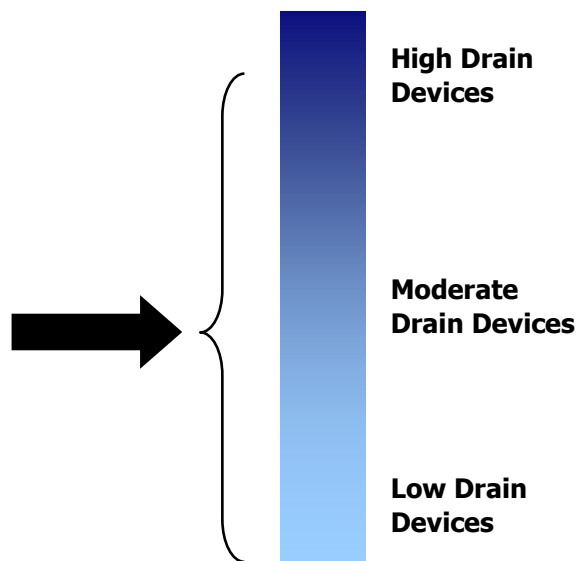

**Important Notice**

This data sheet contains typical information specific to products manufactured at the time of its publication.  
©Energizer Holdings, Inc. - Contents herein do not constitute a warranty.

**ENERGIZER E95**



**Constant Resistance Performance**

Typical Characteristics (21°C)

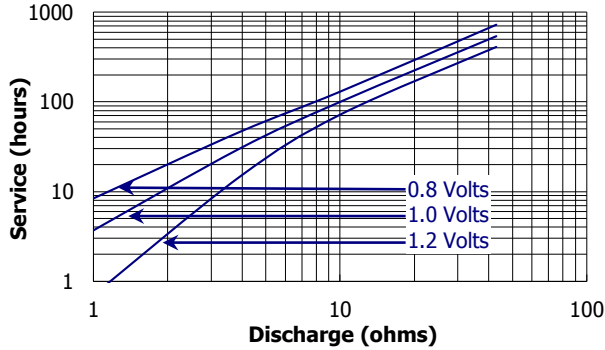

**Constant Current Performance**

Typical Characteristics (21°C)

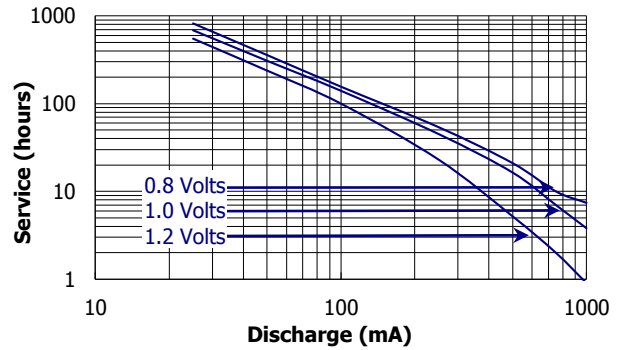

**Industry Standard Tests (21°C)**

**RADIO**  
10 ohm 4 hrs/day

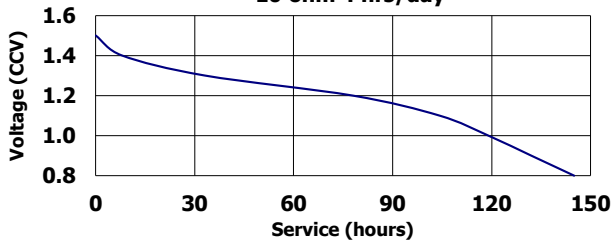

**LIGHTING**  
1.5 ohm HIF      **LIGHTING**  
2.2 ohm LIF

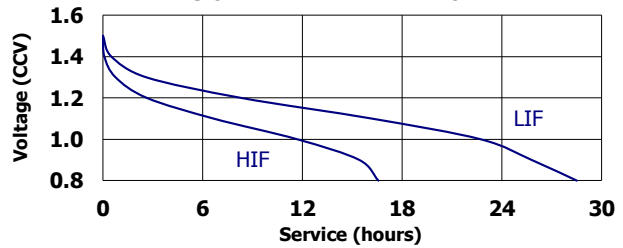

**TOY**  
2.2 ohm 1 hr/day

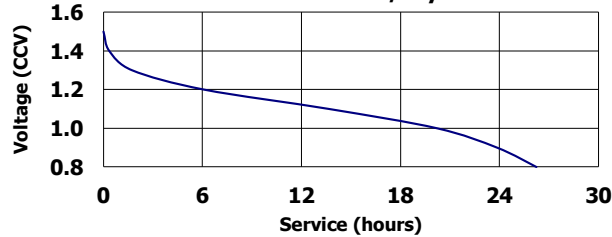

**PORTABLE STEREO**  
600 mA 2 hrs/day

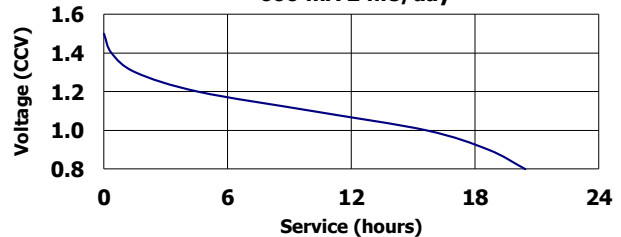

**Important Notice**

This data sheet contains typical information specific to products manufactured at the time of its publication.  
©Energizer Holdings, Inc. - Contents herein do not constitute a warranty.